

6" Balustrade System

PARTS LIST

ITEM	QTY
A PORCH POST INSTALLATION KIT (INCLUDED WITH PORCH POST, SEE FIG. 3C)	
Galvanized Column Mounting Plate	2
#14 x 2" Stainless Steel Sheet Metal Screw	4
B Porch Post (PP8X96) (Includes Installation Kit)	
C Baluster Top Rail (BTR6X96 or BTR6X144)	
D Baluster	
E Baluster Bottom Rail (BBR6X96 or BBR6X144)	
F Rail Support Block (RSB4X4X6)	
G Post Top (PST10X10P shown or PST10X10F)	
H Newel Post (NP8X48)	
J BALUSTER RAIL INSTALLATION KIT (BRK6-7) (SEE FIG. 5A, 5B)	
4" Wide x 1 1/2" x 2" Angle Bracket	2
#14 x 2 1/2" Stainless Steel Flat Head Screw	8
K NEWEL POST INSTALLATION KIT (NPK8) (SEE FIG. 4A, 4B, 4C)	
3/8" - 16 Hex Nut	2
3/8" Lock Washer	2
3/8" USS Flat Washer	2
1/4" x 6 1/2" Diameter Steel Top Mounting Plate	1
3/8" - 16 x 50" Threaded Rod	2
1/4" x 3 1/2" x 3 1/2" Steel Base Plate <i>Note: Fasteners to mount Steel Base Plate to floor surface not provided.</i>	1
L OPTIONAL DECORATIVE TRIM COLLAR (TC8)	
7 1/2" x 7 1/2" Trim Collar	

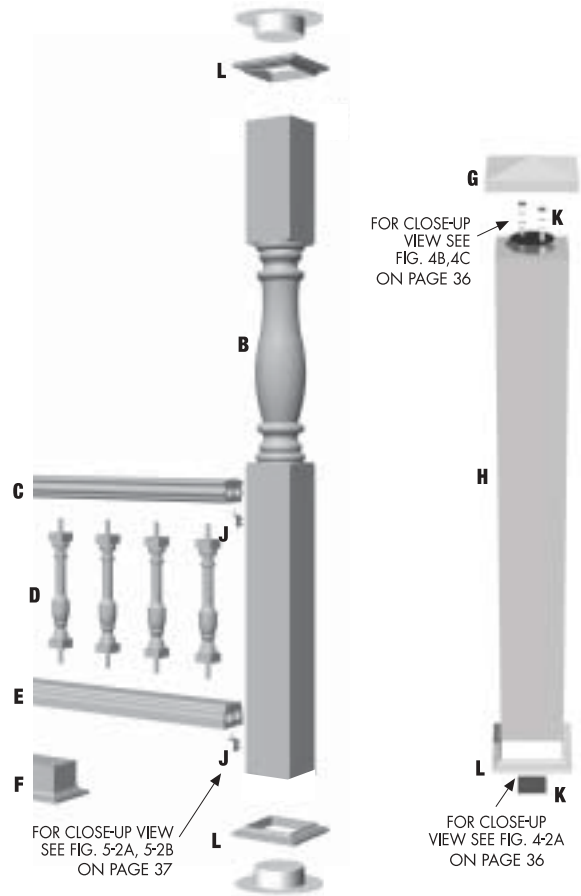

CHECK APPLICABLE BUILDING CODES since this procedure may require alterations to meet applicable building code regulations. The manufacturer does not, under any circumstances, warrant the **INSTALLATION** of its products. The installation guidelines are to be used as suggestions for successful installation.

USING CORROSION-RESISTANT FASTENERS AND PL PREMIUM ADHESIVE

Always use corrosion-resistant mechanical fasteners (nails or screws) and PL Premium Adhesive when installing Pacific Columns products. This combination provides a secure, long lasting bond. Countersink all fasteners about 1/8 inch and fill with exterior grade white spackle. If desired, sand any minor imperfections and topcoat with a quality exterior latex or oil base paint. Pacific Columns exterior millwork installations should be finished using a quality, exterior grade silicone caulk to prevent water infiltration behind siding, windows and doors. Some exterior millwork installations, in particular new construction (before siding is applied) may require a J-channel and/or flashing to prevent water infiltration. Installers must determine which installation technique is best for the specific situation.

IMPORTANT:

Please read these installation guidelines thoroughly before beginning installation. Please note that these guidelines are provided only to assist with the installation of Pacific Columns mouldings and millwork products. Modified procedures may be required in order to meet specific situations, unique applications and local building codes. The manufacturer does not under any circumstances warrant the installation of its products. Be sure to wear appropriate protective clothing, gloves and safety glasses when working with any tools. Installer should check for and relocate all electrical wiring within the proposed installation area, as needed (be sure to disconnect all electric power before working with any electrical wiring and follow all applicable local electrical codes and safety procedures).

6" Balustrade Systems

INSTALLATION INSTRUCTIONS



1. INITIAL LAYOUT

Mark layout lines on floor surface where all PORCH POSTS and NEWEL POSTS will be located. Allow dimensions for the layout of both NEWEL POSTS and PORCH POSTS.

Note: This layout is important in order to get accurate measurements for the actual length of each TOP and BOTTOM RAIL.

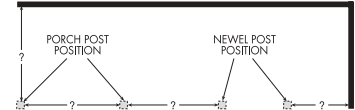

STEP 1

2. BUILD UP AND ASSEMBLE RAIL SECTIONS

To speed up field installations, build up and assemble the BALUSTRADE RAIL SECTIONS in a shop setting when possible. Follow up with easy installation between the supporting posts out on the job site.

- A) Using accurate field measurements (taken in Step 1) cut the matching TOP and BOTTOM RAILS to length for each respective section.
- B) Lay out and mark center lines on RAILS. Mark BALUSTER positions then drill holes to accept BALUSTERS. The diameter of the drilled holes will vary according to the BALUSTRADE size. Tip: A drill press with standard woodworking drill bits works well for drilling these holes.
- C) Apply a 1/4" bead of urethane base construction adhesive on each end of BALUSTER. Then insert BALUSTER into the drilled TOP and BOTTOM RAIL.
- D) Lay the RAIL ASSEMBLY on a flat surface. Use strap clamps as needed to draw RAIL ASSEMBLY together. Clamp tightly and allow the adhesive to set up. (This usually takes a minimum of 12 hours.) As the RAIL ASSEMBLY is drying, before it sets up, make sure it is square and that the BALUSTERS are square to the RAIL SECTION. Clean off any excess adhesive with a putty knife before the adhesive sets. Do not handle the newly assembled RAIL SECTIONS until the adhesive has cured completely. If painting is desired, a good time to paint the RAIL SECTIONS would be now, before field assembly begins.



STEP 2C



STEP 2D

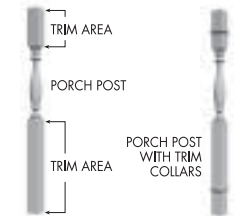

STEP 3B

3. INSTALL PORCH POSTS

- FOR PP6X96 ONLY**
- A) The PORCH POST is a load bearing support post. It can be trimmed to various heights in the top or bottom flat post areas without affecting the integrity of the POST. However, the PORCH POST has a steel pipe molded into the center which must be cut with a hack saw or Sawzall with metal cutting blades.
 - B) Slide TRIM COLLARS along POST.
 - C) Install the 2" wide x 1 1/2" x 2" angle brackets as shown in Fig. 3C. Drill 1/8" x 2 1/2" pilot hole for #14 x 2 1/2" stainless steel flat head screws. (Masonry fasteners not included.) Then slide TRIM COLLARS over the brackets. Secure with adhesive and trim nails.

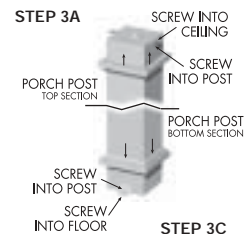

STEP 3C

- FOR PP8X96 ONLY**
- A) Determine the required height of the PORCH POST by carefully measuring the distance from the floor to the bottom of the porch overhang or other structure being supported.
 - B) Pacific Columns PORCH POST are trimmed for height at the bottom. Transfer the measurement from Step One, above, marking all the way around the base of the POST. Carefully cut the polymer shell of the POST using a circular saw or hand saw, being careful to not cut into the steel reinforcement. Then cut through the steel reinforcement using a hack saw or power reciprocating saw with a steel cutting blade.

INSTALLATION INSTRUCTIONS CONTINUED ON FOLLOWING PAGE.

USING CORROSION-RESISTANT FASTENERS AND PL PREMIUM ADHESIVE

Always use corrosion-resistant mechanical fasteners (nails or screws) and PL Premium Adhesive when installing Pacific Columns products. This combination provides a secure, long lasting bond. Countersink all fasteners about 1/8 inch and fill with exterior grade white spackle. If desired, sand any minor imperfections and topcoat with a quality exterior latex or oil base paint. Pacific Columns exterior millwork installations should be finished using a quality, exterior grade silicone caulk to prevent water infiltration behind siding, windows and doors. Some exterior millwork installations, in particular new construction (before siding is applied) may require a J-channel and/or flashing to prevent water infiltration. Installers must determine which installation technique is best for the specific situation.

IMPORTANT:

Please read these installation guidelines thoroughly before beginning installation. Please note that these guidelines are provided only to assist with the installation of Pacific Columns mouldings and millwork products. Modified procedures may be required in order to meet specific situations, unique applications and local building codes. The manufacturer does not under any circumstances warrant the installation of its products. Be sure to wear appropriate protective clothing, gloves and safety glasses when working with any tools. Installer should check for and relocate all electrical wiring within the proposed installation area, as needed (be sure to disconnect all electric power before working with any electrical wiring and follow all applicable local electrical codes and safety procedures).

6" Balustrade Systems (continued)

INSTALLATION INSTRUCTIONS



- C) After cutting through the steel tubing, pre-drill holes approximately 3/4" up from the bottom of the POST using a 13/64" drill bit. These holes should enter the side of the POST at a right angle and go through both the polymer shell and the steel reinforcement. Now use a 1/2" drill bit to expand the drill holes through the polymer only (do not drill through the steel reinforcement) using the 13/64" holes as pilot holes. These 1/2" holes will allow the screw head to go all the way to the steel reinforcement. Repeat this process at the top of the POST, pre-drilling holes approximately 3/4" from the top and centered on the top side.
- D) Paint all exposed steel at both the top and bottom of the POST, using a quality, zinc base primer spray paint (Rust-Oleum®, etc.) to help prevent corrosion.
- E) Determine the proper location for top and bottom column mounting plates. Be careful to mark these locations precisely, so that the top and bottom plates line up directly above and below each other. Identify the correct location of the top plate first, and use a plumb line dropped from the center point of the top plate location to accurately align the center point location for the bottom column mounting plate.
- F) Install the top and bottom column mounting plates using corrosion resistant mechanical fasteners. For anchoring into wooden floors, ceilings and other structures, stainless steel flat head screws are recommended. For installation into concrete, stone or other floor and ceiling materials, appropriate masonry and/or other fasteners must be used.
- G) Set the POST into place beneath the top anchor. Lift (jack) the upper structure just high enough to allow the POST to be set into place above the bottom anchor.
- H) Use the 13/64" holes drilled in Step 3 as guide holes to drill 13/64" holes through the column mounting plates. Firmly attach the POST to the top and bottom plates, driving the corrosion resistant screws provided all the way in so that their heads are flush against the steel tubing (four screws provided, two for the top plate and two for the bottom).
- I) Patch screw holes using a quality exterior grade, non-shrinking wood filler. Once the filler has dried, lightly sand any minor imperfections and paint the POST as desired using a quality exterior grade latex or oil base paint.

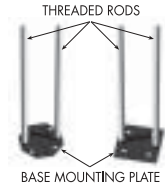

STEP 4A

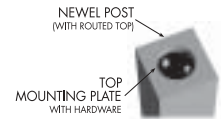

STEP 4B

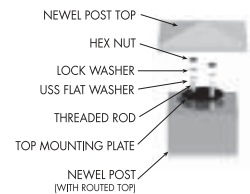

STEP 4C

4. INSTALL NEWEL POSTS

- A) Center the steel BASE MOUNTING PLATE within layout lines marked out in Step 1. Mount them securely to floor surface (fasteners to mount to floor surface not provided). Install and tighten the two 3/8" - 16 x 50" THREADED RODS into MOUNTING PLATE.
- B) The NEWEL POST may be trimmed to a desired height (measure and cut from the unrouted end of the POST). To install the POST align the POST over the THREADED RODS. Install the steel TOP MOUNTING PLATE over the THREADED RODS into the recessed cavity of the NEWEL POST TOP which is routed to accept the hardware. Install 3/8" flat and lock washers and tighten with 3/8" nuts to 100 in./lbs. torque.
- C) TRIM COLLARS may be used on the bottom of the NEWEL POSTS to add a finishing touch. (SEE PARTS LISTS.) Slide the COLLARS over the top of the NEWEL POST into position before the NEWEL POST TOP is fastened in place.
- D) Finish NEWEL POST by attaching NEWEL POST TOP. Apply urethane base construction adhesive then nail or screw TOP into position.

INSTALLATION INSTRUCTIONS CONTINUED ON FOLLOWING PAGE.

USING CORROSION-RESISTANT FASTENERS AND PL PREMIUM ADHESIVE

Always use corrosion-resistant mechanical fasteners (nails or screws) and PL Premium Adhesive when installing Pacific Columns products. This combination provides a secure, long lasting bond. Countersink all fasteners about 1/8 inch and fill with exterior grade white spackle. If desired, sand any minor imperfections and topcoat with a quality exterior latex or oil base paint. Pacific Columns exterior millwork installations should be finished using a quality, exterior grade silicone caulk to prevent water infiltration behind siding, windows and doors. Some exterior millwork installations, in particular new construction (before siding is applied) may require a J-channel and/or flashing to prevent water infiltration. Installers must determine which installation technique is best for the specific situation.

IMPORTANT:

Please read these installation guidelines thoroughly before beginning installation. Please note that these guidelines are provided only to assist with the installation of Pacific Columns mouldings and millwork products. Modified procedures may be required in order to meet specific situations, unique applications and local building codes. The manufacturer does not under any circumstances warrant the installation of its products. Be sure to wear appropriate protective clothing, gloves and safety glasses when working with any tools. Installer should check for and relocate all electrical wiring within the proposed installation area, as needed (be sure to disconnect all electric power before working with any electrical wiring and follow all applicable local electrical codes and safety procedures).

6" Balustrade Systems (continued)

INSTALLATION INSTRUCTIONS



STEP 5

5-1. INSTALL 5" RAIL SECTIONS

With all POSTS in position, screw ANGLE BRACKETS to the POST or wall surface. Drill 1/8" x 2 1/2" pilot hole for screws. The RAIL ASSEMBLY is positioned snugly between the POSTS and secured in place using the same ANGLE BRACKETS. This step requires three stainless steel flat head screws (#14 x 2 1/2").

- A) Determine height of RAIL and fasten top ANGLE BRACKET securely to POST using two screws.
- B) Fasten bottom ANGLE BRACKET to underside of RAIL SECTION using one screw.
- C) Apply urethane base construction adhesive to the ends of RAIL that come in contact with POST. Position RAIL ASSEMBLY between POST and install remaining screws.

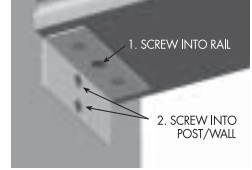

STEP 5-3A

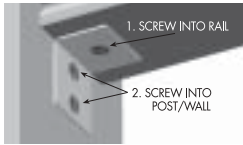

STEP 5-1A

5-2. INSTALL 6" RAIL SECTIONS

With all POSTS in position, screw ANGLE BRACKETS to the POST or wall surface. Drill 1/8" x 2 1/2" pilot hole for screws. The RAIL ASSEMBLY is positioned snugly between the POSTS and secured in place using the same ANGLE BRACKETS. This step requires three stainless steel flat head screws (#14 x 2 1/2").

- A) Determine height of RAIL and fasten top ANGLE BRACKET securely to POST using two screws.
- B) Fasten bottom ANGLE BRACKET to underside of RAIL SECTION using one screw.
- C) Apply urethane base construction adhesive to the ends of RAIL that come in contact with POST. Position RAIL ASSEMBLY between POST and install remaining screws.



STEP 5-3B



STEP 5-1B

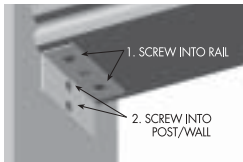

STEP 5-2A

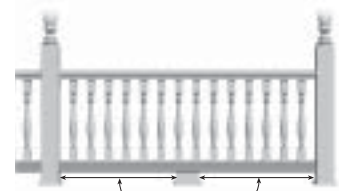

STEP 6

5-3. INSTALL 7" RAIL SECTIONS

With all POSTS in position, screw ANGLE BRACKETS to the POST or wall surface. Drill 1/8" x 2 1/2" pilot hole for screws. The RAIL ASSEMBLY is positioned snugly between the POSTS and secured in place using the same ANGLE BRACKETS. This step requires three stainless steel flat head screws (#14 x 2 1/2").

- A) Determine height of RAIL and fasten top ANGLE BRACKET securely to POST using two screws.
- B) Fasten bottom ANGLE BRACKET to underside of RAIL SECTION using one screw.
- C) Apply urethane base construction adhesive to the ends of RAIL that come in contact with POST. Position RAIL ASSEMBLY between POST and install remaining screws.



STEP 5-2B

6. RAIL SUPPORT BLOCKS

RAIL SUPPORT BLOCKS should be placed under the BOTTOM RAIL at a span of every 48" or less. These blocks can be trimmed for height.

7. FINISHING

All exposed fastener heads should be countersunk and filled with automotive body filler (example: Bondo). Allow filler to cure then sand flush to the millwork surface. Caulk any gaps with a good quality exterior caulk any good quality latex or oil base paint can be applied over the factory finish.

USING CORROSION-RESISTANT FASTENERS AND PL PREMIUM ADHESIVE

Always use corrosion-resistant mechanical fasteners (nails or screws) and PL Premium Adhesive when installing Pacific Columns products. This combination provides a secure, long lasting bond. Countersink all fasteners about 1/8 inch and fill with exterior grade white spackle. If desired, sand any minor imperfections and topcoat with a quality exterior latex or oil base paint. Pacific Columns exterior millwork installations should be finished using a quality, exterior grade silicone caulk to prevent water infiltration behind siding, windows and doors. Some exterior millwork installations, in particular new construction (before siding is applied) may require a J-channel and/or flashing to prevent water infiltration. Installers must determine which installation technique is best for the specific situation.

IMPORTANT:

Please read these installation guidelines thoroughly before beginning installation. Please note that these guidelines are provided only to assist with the installation of Pacific Columns mouldings and millwork products. Modified procedures may be required in order to meet specific situations, unique applications and local building codes. The manufacturer does not under any circumstances warrant the installation of its products. Be sure to wear appropriate protective clothing, gloves and safety glasses when working with any tools. Installer should check for and relocate all electrical wiring within the proposed installation area, as needed (be sure to disconnect all electric power before working with any electrical wiring and follow all applicable local electrical codes and safety procedures).

GENERAL INFORMATION

Before installation, please keep in mind that Pacific Columns products:

- Should be used for decorative purposes only, not to provide structural support (except Structural Columns, Balustrade Systems and Porch Posts).
- Should never be installed with mechanical fasteners only. For best results always use non-corrosive fasteners along with urethane base PL Premium Adhesive.
- Are easy to repair. Use wood filler or automotive filler to quickly fill dents or gashes of any size. Broken moulding can be successfully rejoined with urethane base PL Premium Adhesive.
- Should not be stored in extreme heat. Acclimate before installation. Due to urethane's high insulating value, this may take up to 10 hours.
- Will resist the elements, except for direct sunlight to the yellowish (unpainted) underside of the millwork. It is important to fill damaged or cut surfaces with putty, caulk, and/or paint within a few days.
- Can withstand temperatures of about 140°F (60°C). However, the millwork should never be placed in an area subject to solar temperature buildup, such as behind a storm door.
- Can be used safely in accordance with SBCCI, BOCA, CABO and NFPA rulings. There are no official independent laboratory fire test results for Pacific Columns products. The products are equivalent to any decorative urethane products not specifically formulated for fire resistance.
- May require altered installation procedures to meet local specifications. Check local building codes.

The installation suggestions in this catalog are to be used only as a guideline. Pacific Columns, Inc. assumes no liability for any damages, including but not limited to personal, property, incidental, or consequential damages, resulting from the installation of its products. Pacific Columns, Inc.'s sole responsibility in connection with the sale and installation of its products is the limited warranty set forth below.

PACIFIC COLUMNS LIMITED WARRANTY

Pacific Columns, Incorporated warrants to the original consumer purchaser that our exterior white primer paint finish will be free from UV ray degradation, blistering, and paint peeling under normal use for a period of one (1) year from the date of purchase.

We further provide a LIFETIME WARRANTY to the original purchaser on the urethane material. This LIFETIME WARRANTY provides that the urethane material will be free from defects in material and workmanship under normal use.

If a defect is found in a Pacific Columns product and the above conditions have been met, a customer should notify Pacific Columns in writing within thirty (30) days of discovering the defect. The customer may be required to return the product to Pacific Columns (at his or her expense) for evaluation. Pacific Columns will then review the situation and determine if replacement, repair or refund of the product is appropriate. This warranty does not include labor, transportation costs or any other expenses of any kind incurred in connection with the purchase, use or installation of the product. Replacement, repair or refund is the sole and exclusive option under this limited warranty.

This limited warranty does not cover damage resulting from mishandling in transit (if within the customer's control), acts of God, customer alteration, vandalism, misuse, abuse, improper maintenance, unreasonable care or other causes not arising from defects in workmanship and materials. THERE ARE NO WARRANTIES, EXPRESS OR IMPLIED, WRITTEN OR ORAL, INCLUDING ANY WARRANTIES OF MERCHANTABILITY OR FITNESS FOR PURPOSE, OTHER THAN AS EXPRESSED HEREIN. No person, agent, distributor, dealer, service facility, or company is authorized to change, modify or amend the terms of this limited warranty in any manner or fashion whatsoever, except to the extent provided in this limited warranty. Pacific Columns, Inc. shall not be liable to the customer or to any other person for any incidental or consequential damages or loss of profit resulting from any defect in the product.

Some states do not allow limitations on how long an implied warranty lasts, or the exclusion or limitation of incidental or consequential damages, so that the above limitation or exclusion may not apply. This warranty gives you specific legal rights. You may also have other rights which vary from state to state.