

7" Balustrade System
Baluster - Ashley (AY)

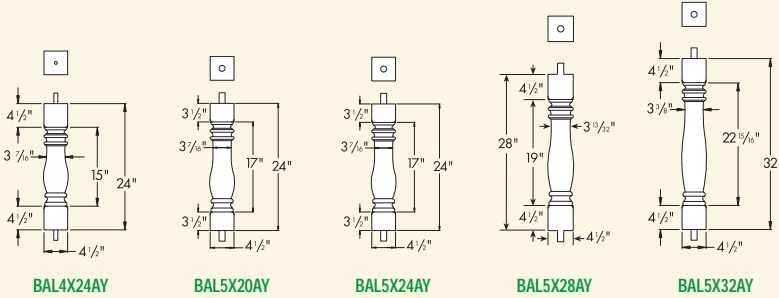

Part Number Maximum Center-to-Center Distance To Meet 4" Rule.
(See Page 2 BL For Details)

NEW BAL4X24AY	7 3/8"	
NEW BAL5X20AY	7 7/8"	
NEW BAL5X24AY	7 3/8"	
NEW BAL5X28AY	7 5/16"	
NEW BAL5X32AY	7 5/16"	

7" Balustrade System
Baluster - Beaumont (BE)

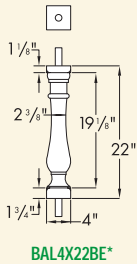

Part Number Maximum Center-to-Center Distance To Meet 4" Rule.
(See Page 2 BL For Details)

NEW BAL4X22BE*	6 5/16"	
-----------------------	---------	--

*Cannot be used for stair applications.

7" Balustrade System
Baluster - Jillian (JI)

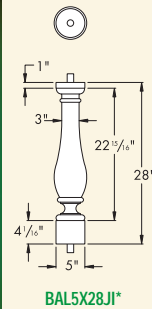

Part Number Maximum Center-to-Center Distance To Meet 4" Rule.
(See Page 2 BL For Details)

NEW BAL5X28JI*	6 15/16"	
-----------------------	----------	--

*Cannot be used for stair applications.

7" Balustrade System Baluster - Classic (CC)

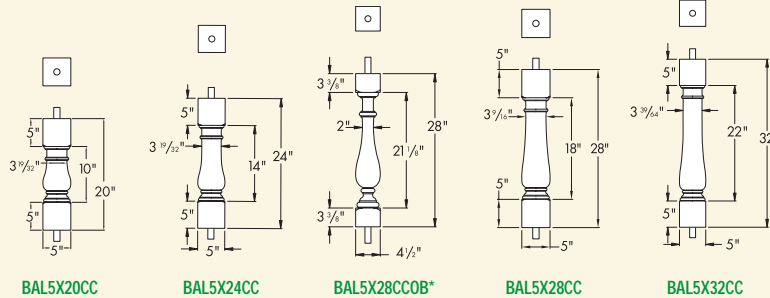

Part Number Maximum Center-to-Center Distance To Meet 4" Rule.
(See Page 2 BL For Details)

NEW BAL5X20CC	7 5/8"	
NEW BAL5X24CC	7 1/2"	
BAL5X28CCOB*	5 15/16"	
NEW BAL5X28CC	7 1/2"	
NEW BAL5X32CC	7 9/16"	

*Cannot be used for stair applications.

7" Balustrade System Baluster - Logan (LN)

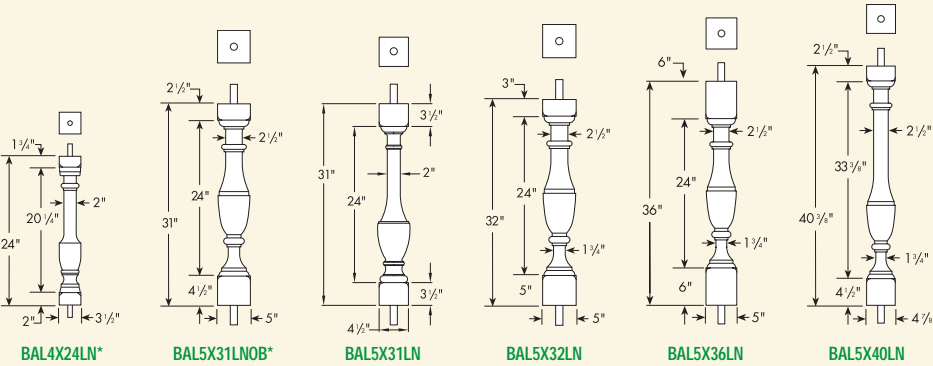

Part Number Maximum Center-to-Center Distance To Meet 4" Rule.
(See Page 2 BL For Details)

BAL4X24LN*	5 15/16"	
BAL5X31LNQB*	6 7/16"	
NEW BAL5X31LN	6 7/16"	
BAL5X32LN	6 7/16"	
BAL5X36LN	6 15/16"	
BAL5X40LN	6 7/16"	

*Cannot be used for stair applications.

7" Balustrade System
Baluster - Piedmont (PM)

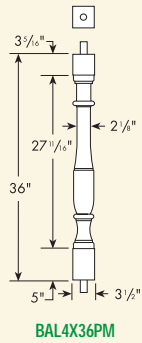

BAL4X36PM

Part Number

Maximum Center-to-Center Distance To Meet 4" Rule.
(See Page 2 BL For Details)

BAL4X36PM

6 1/16"

7" Balustrade System
Baluster - Square (SQ)

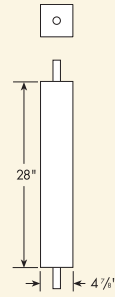
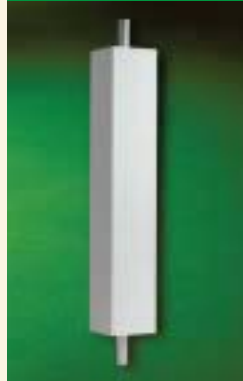

BAL5X28SQ

Part Number

Maximum Center-to-Center Distance To Meet 4" Rule.
(See Page 2 BL For Details)

NEW BAL5X28SQ

8 13/16"

7" Balustrade System
Baluster - Rosedale (RL)

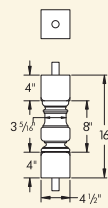

BAL5X16RL

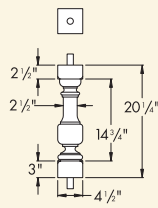

BAL5X20RLOB*

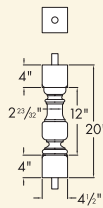

BAL5X20RL

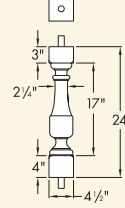

BAL5X24RLOB*

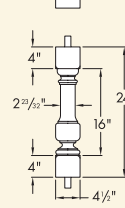

BAL5X24RL

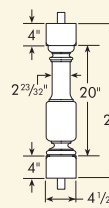

BAL5X28RL

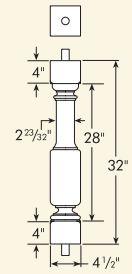

BAL5X32RL

Part Number

Maximum Center-to-Center Distance To Meet 4" Rule.
(See Page 2 BL For Details)

NEW BAL5X16RL

7 7/32"

BAL5X20RLOB*

6 7/16"

NEW BAL5X20RL

6 5/8"

BAL5X24RLOB*

6 3/16"

NEW BAL5X24RL

6 5/8"

NEW BAL5X28RL

6 5/8"

NEW BAL5X32RL

6 5/8"

*Cannot be used for stair applications.



7" Balustrade System
Baluster - Trinity (TY)

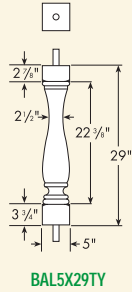

BAL5X29TY

Part Number	Maximum Center-to-Center Distance To Meet 4" Rule. <i>(See Page 2 BL For Details)</i>	
BAL5X29TY	6 7/16"	

7" Balustrade System
Baluster - Woodruff (WF)

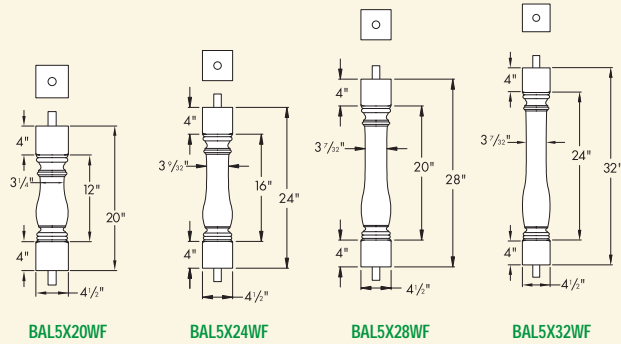

BAL5X20WF

BAL5X24WF

BAL5X28WF

BAL5X32WF

Part Number	Maximum Center-to-Center Distance To Meet 4" Rule. <i>(See Page 2 BL For Details)</i>	
NEW BAL5X20WF	7 3/16"	
NEW BAL5X24WF	7 3/8"	
NEW BAL5X28WF	7 3/16"	
NEW BAL5X32WF	7 3/16"	

7" Balustrade System Top Rail

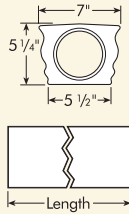

Part Number	Length	Baluster Rail Installation Kit* (See Installation Guide Page 34)
BTR7X96	96"	BRK6-7
BTR7X120	120"	BRK6-7
BTR7X144	144"	BRK6-7

*Connects both ends of one 7" Rail to applications.
May be used for corner or butt connections into NP8X48 or PP8X96.
(2 qty.) 4" wide x 1 1/2" x 2" Angle Brackets.
(8 qty.) #14 x 2 1/2" Stainless Steel Flat Head Screws.

7" Balustrade System Bottom Rail

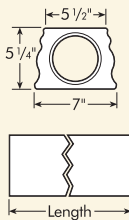

Part Number	Length	Baluster Rail Installation Kit* (See Installation Guide Page 34)	Rail Support Block (See Below)
BBR7X96	96"	BRK6-7	RSB4X4X6
BBR7X120	120"	BRK6-7	RSB4X4X6
BBR7X144	144"	BRK6-7	RSB4X4X6

*Connects both ends of one 7" Rail to applications.
May be used for corner or butt connections into NP8X48 or PP8X96.
(2 qty.) 4" wide x 1 1/2" x 2" Angle Brackets.
(8 qty.) #14 x 2 1/2" Stainless Steel Flat Head Screws.

7" Balustrade System Rail Support Block

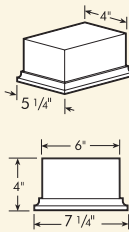
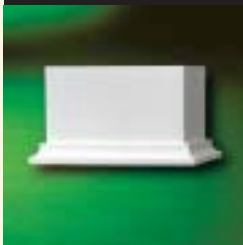

Part Number
RSB4X4X6

Rail Support Blocks should be placed under the Bottom Rail at a span of every 48" or less. These blocks can be trimmed for height.

7" Balustrade System Baluster Top Rail Radius

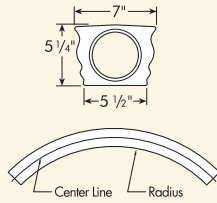

Part Number	Radius	Center Line Length	Baluster Rail Installation Kit* (See Installation Guide Page 34)
NEW BTRR7X24	24"	75" (1/2 Circle)	BRK6-7
BTRR7X58	57 1/2"	96" (1/4 Circle)	BRK6-7
BTRR7X63	63"	99" (1/4 Circle)	BRK6-7
NEW BTRR7X75	74 3/4"	125" (1/4 Circle)	BRK6-7
BTRR7X80	80"	100" (1/5 Circle)	BRK6-7
BTRR7X96	96"	120" (1/5 Circle)	BRK6-7
BTRR7X108	108"	85" (1/8 Circle)	BRK6-7
BTRR7X125	125 1/4"	98" (1/8 Circle)	BRK6-7
NEW BTRR7X126	125 1/2"	98" (1/8 Circle)	BRK6-7
NEW BTRR7X138	138 1/2"	74" (1/12 Circle)	BRK6-7
BTRR7X158	158"	123" (1/8 Circle)	BRK6-7
NEW BTRR7X173	173 1/2"	109" (1/10 Circle)	BRK6-7
NEW BTRR7X210	210"	120" (1/11 Circle)	BRK6-7
BTRR7X271	271"	96" (1/16 Circle)	BRK6-7
NEW BTRR7X297	296 5/8"	147" (1/13 Circle)	BRK6-7

*Connects both ends of one 7" Rail to applications.
May be used for corner or butt connections into NP8X48 or PP8X96.
(2 qty.) 4" wide x 1 1/2" x 2" Angle Brackets.
(8 qty.) #14 x 2 1/2" Stainless Steel Flat Head Screws.

7" Balustrade System Baluster Bottom Rail Radius

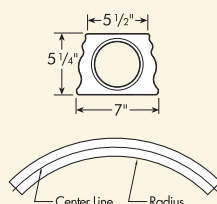
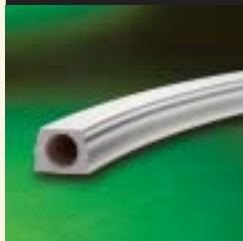

Part Number	Radius	Center Line Length	Baluster Rail Installation Kit* (See Installation Guide Page 34)	Rail Support Block (Page 21 BL)
NEW BBRR7X24	24"	75" (1/2 Circle)	BRK6-7	RSB4X4X6
BBRR7X58	57 1/2"	96" (1/4 Circle)	BRK6-7	RSB4X4X6
BBRR7X63	63"	99" (1/4 Circle)	BRK6-7	RSB4X4X6
NEW BBRR7X75	74 3/4"	125" (1/4 Circle)	BRK6-7	RSB4X4X6
BBRR7X80	80"	100" (1/5 Circle)	BRK6-7	RSB4X4X6
BBRR7X96	96"	120" (1/5 Circle)	BRK6-7	RSB4X4X6
BBRR7X108	108"	85" (1/8 Circle)	BRK6-7	RSB4X4X6

CHART CONTINUED ON FOLLOWING PAGE.

7" Balustrade System Baluster Bottom Rail Radius (continued)

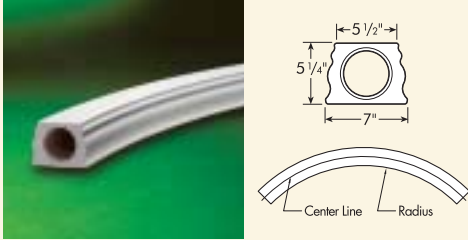
	Part Number	Radius	Center Line Length	Baluster Rail Installation Kit* (See Installation Guide Page 34)	Rail Support Block (Page 21 BL)
	BRRR7X125	125 1/4"	98" (1/8 Circle)	BRK6-7	RSB4X4X6
	NEW BRRR7X126	125 1/2"	98" (1/8 Circle)	BRK6-7	RSB4X4X6
	NEW BRRR7X138	138 1/2"	74" (1/12 Circle)	BRK6-7	RSB4X4X6
	BRRR7X158	158"	123" (1/8 Circle)	BRK6-7	RSB4X4X6
	NEW BRRR7X173	173 1/2"	109" (1/10 Circle)	BRK6-7	RSB4X4X6
	NEW BRRR7X210	210"	120" (1/11 Circle)	BRK6-7	RSB4X4X6
	BRRR7X271	271"	96" (1/16 Circle)	BRK6-7	RSB4X4X6
	NEW BRRR7X297	296 5/8"	147" (1/13 Circle)	BRK6-7	RSB4X4X6

*Connects both ends of one 7" Rail to applications.
 May be used for corner or butt connections into NP8X48 or PP8X96.
 (2 qty.) 4" wide x 1 1/2" x 2" Angle Brackets.
 (8 qty.) #14 x 2 1/2" Stainless Steel Flat Head Screws.

7" Balustrade System Porch Post

Post is load bearing and reinforced.*

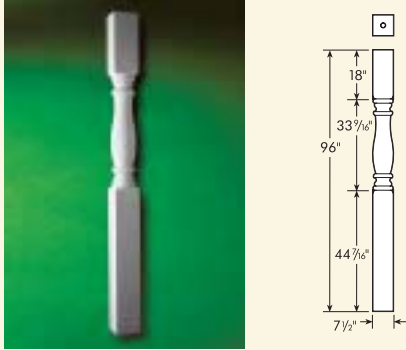
	Part Number	Porch Post Installation Kit** (See Installation Guide Page 34)	Load Rating/Dead Load
	PP8X96	PPK8	3000#
	<p>Note: PPK8 included with this Porch Post.</p>		

*Porch Post can be field trimmed to various heights without losing load rating.
 **Hardware included to secure one PP8X96.
 (2 qty.) Column Mounting Plates.
 (4 qty.) #14 x 2" Stainless Steel Sheet Metal Screws.
 Fasteners to mount angle brackets to floor surface not provided.
 Trim Collar must be ordered separate.

7" Balustrade System Newel Post

One piece Post reinforced, height trimable.

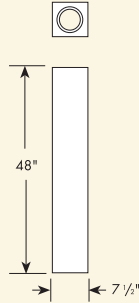

Part Number

Newel Post Installation Kit*
(See Installation Guide Page 34)

NP8X48

NPK8

*Hardware included to secure one NP8X48.

(2 qty.) 3/8" - 16 Hex Nuts.

(2 qty.) 3/8" - Lock Washers.

(2 qty.) 3/8" - Flat Washers.

(1 qty.) 1/4" x 6 1/2" Diameter Steel Top Mounting Plate.

(2 qty.) 3/8" x 50" Threaded Rods.

(1 qty.) 1/4" x 3 1/2" x 3 1/2" Octagon Steel Base Plate.

Fasteners to mount Steel Base Plate to floor surface not provided.

7" Balustrade System Newel Post Accessories

Part Number

Coordinating Newel Post Accessories

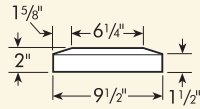

PST10X10F
Post Top - Flat

B5X7

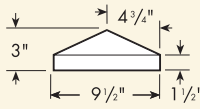

PST10X10P
Post Top - Peaked

—

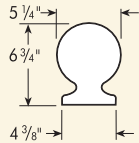

B5X7
Ball

PST10X10F

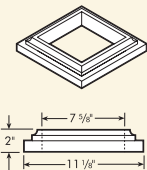

TC8
Base Trim Collar

—