

5" Balustrade System Baluster - Ashley (AY)

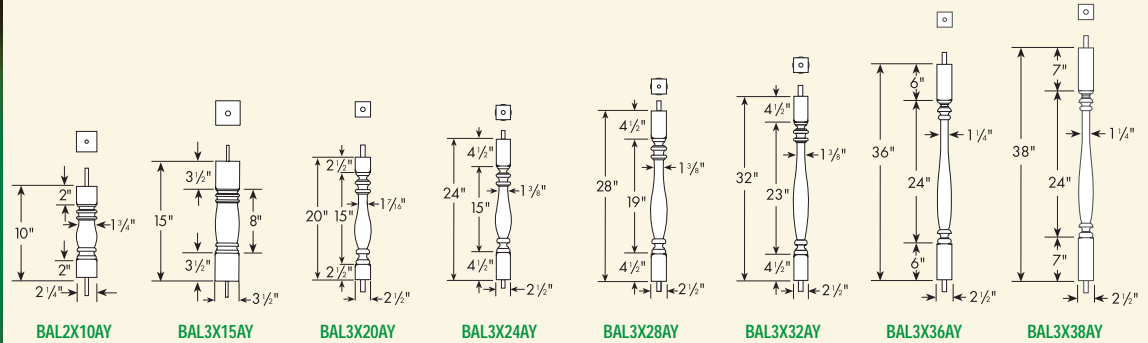

Part Number

Maximum Center-to-Center Distance To Meet 4" Rule.
(See Page 2 BL For Details)

BAL2X10AY	5 7/8"	<i>Ideal for Porch Spandrel application.</i>
BAL3X15AY	5 11/16"	
NEW BAL3X20AY	5 3/8"	
BAL3X24AY	5 7/16"	
BAL3X28AY	5 5/16"	
BAL3X32AY	5 5/16"	
BAL3X36AY	5 3/16"	
BAL3X38AY	5 3/16"	

5" Balustrade System Baluster - Classic (CC)

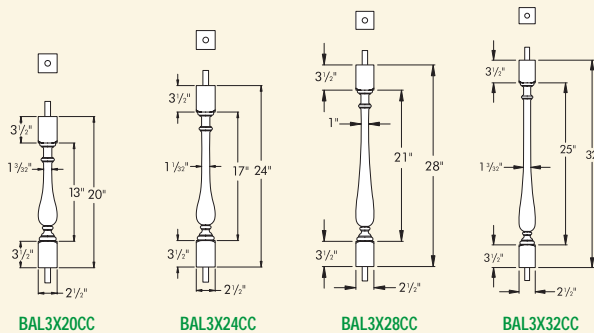

Part Number

Maximum Center-to-Center Distance To Meet 4" Rule.
(See Page 2 BL For Details)

NEW BAL3X20CC	5"	
NEW BAL3X24CC	5"	
NEW BAL3X28CC	4 15/16"	
NEW BAL3X32CC	5"	



5" Balustrade System Baluster - Logan (LN)

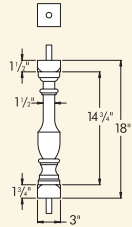

BAL3X18LNOB*

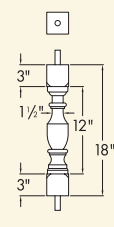

BAL3X18LN

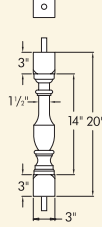

BAL3X20LN

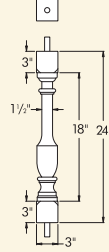

BAL3X24LN

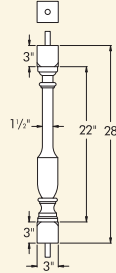

BAL3X28LN

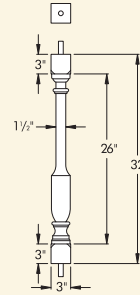

BAL3X32LN

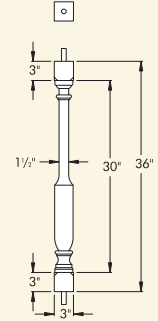

BAL3X36LN

Part Number Maximum Center-to-Center Distance To Meet 4" Rule.
(See Page 2 BL For Details)

BAL3X18LNOB*	5 7/16"	
NEW BAL3X18LN	5 7/16"	
NEW BAL3X20LN	5 7/16"	
NEW BAL3X24LN	5 7/16"	
NEW BAL3X28LN	5 7/16"	
NEW BAL3X32LN	5 7/16"	
NEW BAL3X36LN	5 7/16"	

*Cannot be used for stair applications.

5" Balustrade System Baluster - Rosedale (RL)

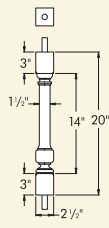

BAL3X20RL

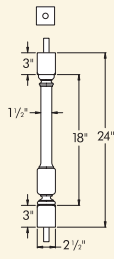

BAL3X24RL

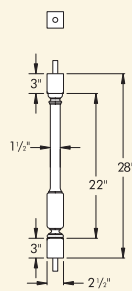

BAL3X28RL

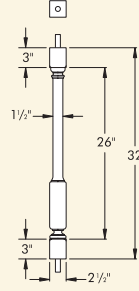

BAL3X32RL

Part Number Maximum Center-to-Center Distance To Meet 4" Rule.
(See Page 2 BL For Details)

NEW BAL3X20RL	5 7/16"	
NEW BAL3X24RL	5 7/16"	
NEW BAL3X28RL	5 7/16"	
NEW BAL3X32RL	5 7/16"	



5" Balustrade System Baluster - Square (SQ)

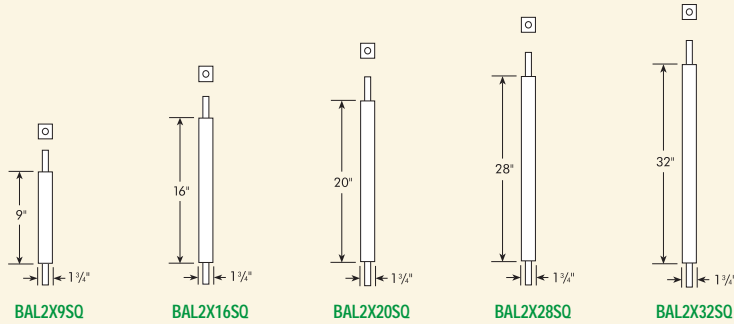

Part Number Maximum Center-to-Center Distance To Meet 4" Rule.
(See Page 2 BL For Details)

NEW BAL2X9SQ	5 11/16"	
BAL2X16SQ	5 11/16"	
BAL2X20SQ	5 11/16"	
BAL2X28SQ	5 11/16"	
BAL2X32SQ	5 11/16"	

5" Balustrade System Baluster - Woodruff (WF)

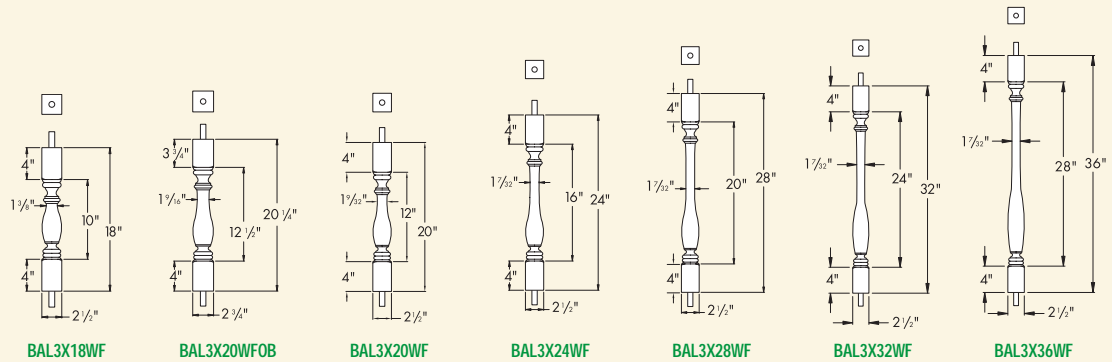

Part Number Maximum Center-to-Center Distance To Meet 4" Rule.
(See Page 2 BL For Details)

NEW BAL3X18WF	5 9/16"	
BAL3X20WFOB	5 1/2"	
NEW BAL3X20WF	5 7/32"	
NEW BAL3X24WF	5 3/16"	
NEW BAL3X28WF	5 3/16"	
NEW BAL3X32WF	5 3/16"	
NEW BAL3X36WF	5 1/8"	

5" Balustrade System Top Rail

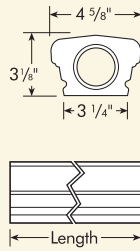

Part Number	Length	Baluster Rail Installation Kit* <small>(See Installation Guide Page 32)</small>	
BTR5X96	96"	BRK5	
BTR5X144 <small>Note: Max. rail span distance for field applications is 96"</small>	144"	BRK5	

*Connects both ends of one 5" Rail to applications.
May be used for corner or butt connections into NP6X48 or PP6X96.
(2 qty.) 2" wide x 1 1/2" x 2" Angle Brackets.
(6 qty.) #14 x 2 1/2" Stainless Steel Flat Head Screws.

5" Balustrade System Bottom Rail

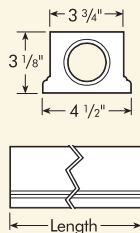

Part Number	Length	Baluster Rail Installation Kit* <small>(See Installation Guide Page 32)</small>		Rail Support Block <small>(See Below)</small>
BBR5X96	96"	BRK5		RSB4X4X6
BBR5X144 <small>Note: Max. rail span distance for field applications is 96"</small>	144"	BRK5		RSB4X4X6

*Connects both ends of one 5" Rail to applications.
May be used for corner or butt connections into NP6X48 or PP6X96.
(2 qty.) 2" wide x 1 1/2" x 2" Angle Brackets.
(6 qty.) #14 x 2 1/2" Stainless Steel Flat Head Screws.

5" Balustrade System Rail Support Block

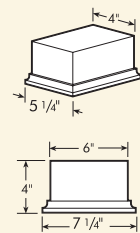
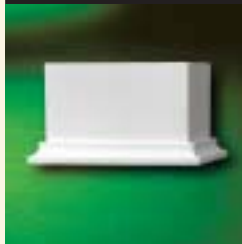

Part Number	
RSB4X4X6	

Rail Support Blocks should be placed under the Bottom Rail at a span of every 48" or less. These blocks can be trimmed for height.

5" Balustrade System Baluster Top Rail Radius

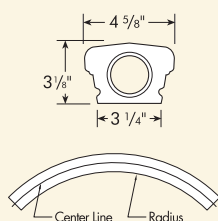

Part Number	Radius	Center Line Length	Baluster Rail Installation Kit* <small>(See Installation Guide Page 32)</small>	
NEW BTRR5X36	36"	56" (1/4 Circle)	BRK5	
NEW BTRR5X60	60"	98" (1/4 Circle)	BRK5	
NEW BTRR5X155	155 1/2"	122" (1/8 Circle)	BRK5	

*Connects both ends of one 5" Rail to applications.
May be used for corner or butt connections into NP8X48 or PP8X96.
(2 qty.) 4" wide x 1 1/2" x 2" Angle Brackets.
(8 qty.) #14 x 2 1/2" Stainless Steel Flat Head Screws.



5" Balustrade System Baluster Bottom Rail Radius

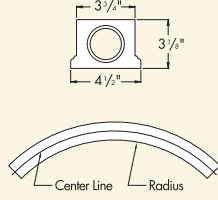

Part Number	Radius	Center Line Length	Baluster Rail Installation Kit* (See Installation Guide Page 32)	Rail Support Block (Page 7 BL)
NEW BBRR5X36	36"	56" (1/4 Circle)	BRK5	RSB4X4X6
NEW BBRR5X60	60"	98" (1/4 Circle)	BRK5	RSB4X4X6
NEW BBRR5X155	155 1/2"	122" (1/8 Circle)	BRK5	RSB4X4X6

*Connects both ends of one 5" Rail to applications.
May be used for corner or butt connections into NP8X48 or PP8X96.
(2 qty.) 4" wide x 1 1/2" x 2" Angle Brackets.
(8 qty.) #14 x 2 1/2" Stainless Steel Flat Head Screws.

5" Balustrade System Porch Post

Post is load bearing and reinforced.*

DIMENSIONS

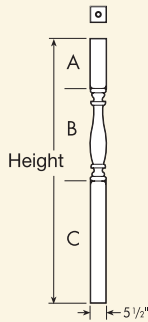

Part Number	Height	A	B	C	Porch Post Installation Kit** (See Installation Guide Page 32)	Load Rating/Dead Load
PP6X96	96"	18"	33 9/16"	47 7/16"	PPK6	3000#
NEW PP6X108	108"	21"	42 1/2"	44 1/2"	PPK6	9000#
NEW PP6X120	120"	26"	49 1/2"	44 1/2"	PPK6	9000#

*Porch Post can be field trimmed to various heights without losing load rating.
**Hardware included to secure one PP6X96.
(2 qty.) 5 1/2" x 5 1/2" Trim Collars (TC6).
(4 qty.) 2" wide x 1 1/2" x 2" Angle Brackets.
(12 qty.) #14 x 2 1/2" Stainless Steel Flat Head Screws.
Fasteners to mount angle brackets to floor surface not provided.

5" Balustrade System Newel Post



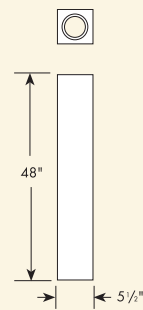



One piece Post reinforced, height trimable.

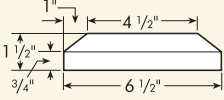

Part Number	Newel Post Installation Kit* (See Installation Guide Page 32)
NP6X48	NPK6

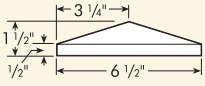
*Hardware included to secure one NP6X48.
(2 qty.) 3/8" - 16 Hex Nuts.
(2 qty.) 3/8" - Lock Washers.
(2 qty.) 3/8" - Flat Washers.
(1 qty.) 1/4" x 4 1/2" Diameter Steel Top Mounting Plate.
(2 qty.) 3/8" x 50" Threaded Rods.
(1 qty.) 1/4" x 3 1/2" x 3 1/2" Octagon Steel Base Plate.
Fasteners to mount Steel Base Plate to floor surface not provided.

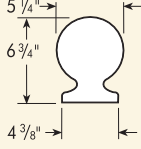
5" Balustrade System
Newel Post Accessories

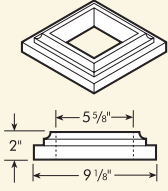
		Part Number	Coordinating Newel Post Accessories	
		PST7X7F Post Top - Flat	B5X7	
		PST7X7P Post Top - Peaked	—	
		B5X7 Ball	PST7X7F	
		TC6 Base Trim Collar	—	

