

12" Balustrade System Baluster - Classic (CC) (continued)

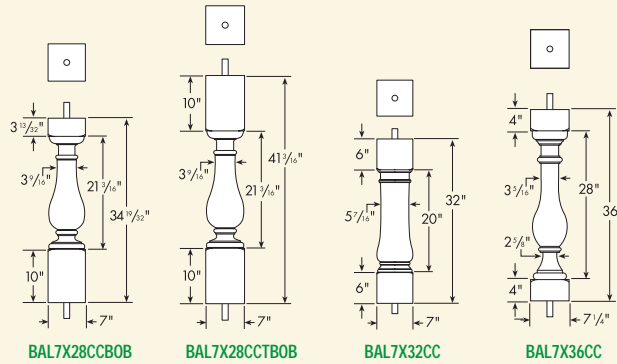

Part Number Maximum Center-to-Center Distance To Meet 4" Rule.
(See Page 2 BL For Details)

BAL7X28CCB0B	7 9/16"	
BAL7X28CCTB0B	7 9/16"	
NEW BAL7X32CC	9 3/8"	
BAL7X36CC	7 1/4"	

12" Balustrade System Baluster - Logan (LN)

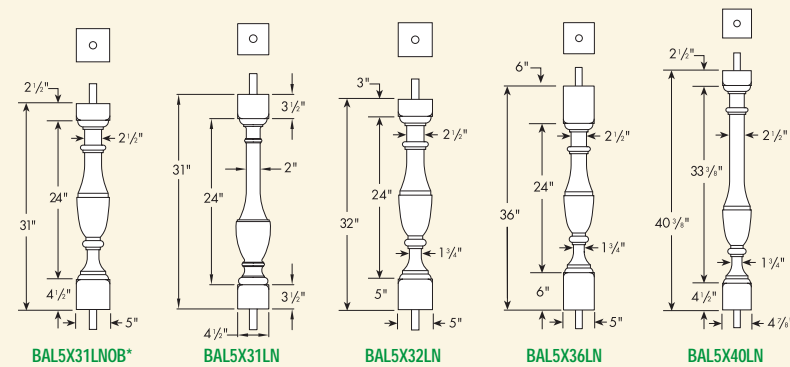

Part Number Maximum Center-to-Center Distance To Meet 4" Rule.
(See Page 2 BL For Details)

BAL5X31LNOB*	6 7/16"	
NEW BAL5X31LN	6 7/16"	
BAL5X32LN	6 7/16"	
BAL5X36LN	6 7/16"	
BAL5X40LN	6 7/16"	

*Cannot be used for stair applications.

12" Balustrade System
Baluster - Rosedale (RL)

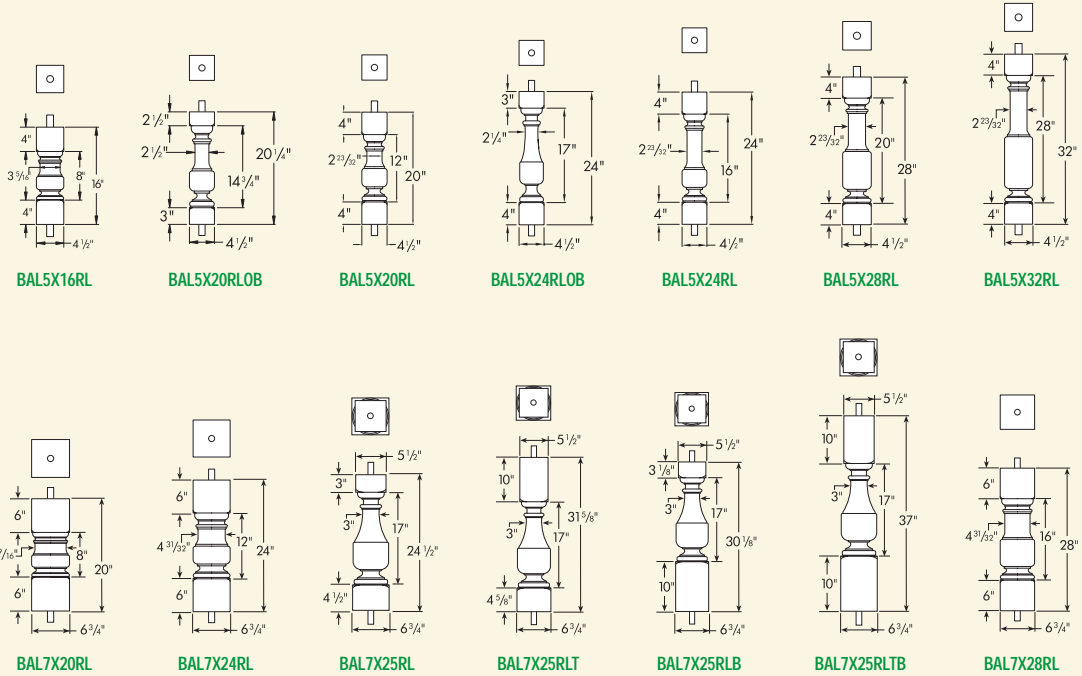

Part Number Maximum Center-to-Center Distance To Meet 4" Rule.
(See Page 2 BL For Details)

NEW BAL5X16RL	7 7/32"	
BAL5X20RLOB	6 7/16"	
NEW BAL5X20RL	6 5/8"	
BAL5X24RLOB	6 3/16"	
NEW BAL5X24RL	6 5/8"	
NEW BAL5X28RL	6 5/8"	
NEW BAL5X32RL	6 5/8"	
NEW BAL7X20RL	9 1/2"	
NEW BAL7X24RL	8 7/8"	
BAL7X25RL	6 15/16"	
BAL7X25RLT	7 1/8"	
BAL7X25RLB	7 1/16"	
BAL7X25RLTB	7 1/8"	
NEW BAL7X28RL	8 7/8"	

CHART CONTINUED ON FOLLOWING PAGE.



12" Balustrade System
Baluster - Rosedale (RL) (continued)

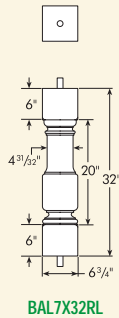

BAL7X32RL

Part Number

Maximum Center-to-Center Distance To Meet 4" Rule.
(See Page 2 BL For Details)

NEW BAL7X32RL

8 7/8"

12" Balustrade System
Baluster - Claremont (CL)

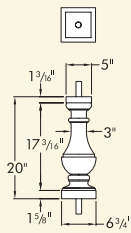

BAL6X20CL*

Part Number

Maximum Center-to-Center Distance To Meet 4" Rule.
(See Page 2 BL For Details)

BAL6X20CL*

7"

*Cannot be used for stair applications.

12" Balustrade System
Baluster - Jillian (JI)

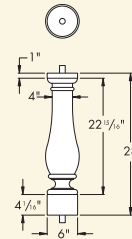

BAL6X28JI*

Part Number

Maximum Center-to-Center Distance To Meet 4" Rule.
(See Page 2 BL For Details)

NEW BAL6X28JI*

7 15/16"

*Cannot be used for stair applications.

12" Balustrade System
Baluster - Trinity (TY)

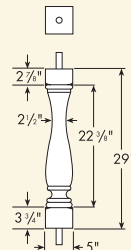

BAL5X29TY

Part Number

Maximum Center-to-Center Distance To Meet 4" Rule.
(See Page 2 BL For Details)

BAL5X29TY

6 7/16"

12" Balustrade System
Baluster - Square (SQ)

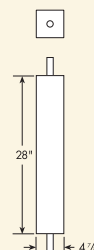

BAL5X28SQ

Part Number

Maximum Center-to-Center Distance To Meet 4" Rule.
(See Page 2 BL For Details)

NEW BAL5X28SQ

8 13/16"



12" Balustrade System Top Rail

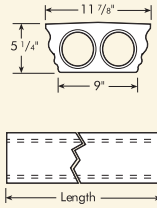

Part Number	Length	Baluster Rail Installation Kit* <small>(See Installation Guide Page 38)</small>	
BTR12X96	96"	BRK12	
BTR12X120	120"	BRK12	

*Connects both ends of one 12" Rail to applications.
 (4 qty.) Bear Claw Brackets.
 (16 qty.) #12 x 3/4" Pan Head Screws.
 (4 qty.) 3/16"-18 x 5" Hex Head Cap Screws.
 (2 qty.) 1/4"-20 x 2" Flat Head Phillips Thread Cutting Screws.
 (4 qty.) 3/16" Clip Nuts.
 (4 qty.) 1 1/2" O.D. x 3/16" I.D. x 3/64" thick Fender Washers.

12" Balustrade System Bottom Rail

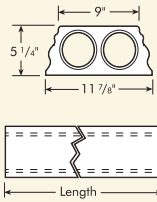

Part Number	Length	Baluster Rail Installation Kit* <small>(See Installation Guide Page 38)</small>		Rail Support Block <small>(See Below)</small>
BBR12X96	96"	BRK12		RSB4X4X6
BBR12X120	120"	BRK12		RSB4X4X6

*Connects both ends of one 12" Rail to applications.
 (4 qty.) Bear Claw Brackets.
 (16 qty.) #12 x 3/4" Pan Head Screws.
 (4 qty.) 3/16"-18 x 5" Hex Head Cap Screws.
 (2 qty.) 1/4"-20 x 2" Flat Head Phillips Thread Cutting Screws.
 (4 qty.) 3/16" Clip Nuts.
 (4 qty.) 1 1/2" O.D. x 3/16" I.D. x 3/64" thick Fender Washers.

12" Balustrade System Rail Support Block

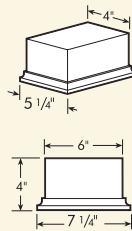

Part Number	
RSB4X4X6	

Rail Support Blocks should be placed under the Bottom Rail at a span of every 48" or less. These blocks can be trimmed for height.

12" Balustrade System Baluster Top Rail Radius

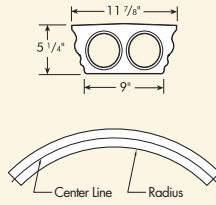

Part Number	Radius	Center Line Length	Baluster Rail Installation Kit* (See Installation Guide Page 38)
BTRR12X48	48"	75" (1/4 Circle)	BRK12
BTRR12X60	60"	94" (1/4 Circle)	BRK12
BTRR12X77	76 1/2"	122" (1/4 Circle)	BRK12
BTRR12X96	96"	120" (1/5 Circle)	BRK12
BTRR12X110	110"	78" (1/8 Circle)	BRK12
BTRR12X126	126"	102" (1/8 Circle)	BRK12
NEW BTRR12X192	192 1/2"	100" (1/12 Circle)	BRK12
BTRR12X247	246 15/16"	98" (1/16 Circle)	BRK12

*Includes hardware to mount top and bottom rail to a baluster:
 (4 qty.) Bear Claw Brackets.
 (4 qty.) 3/16"-18 Clip Nuts.
 (16 qty.) #12 x 3/4" Pan Head Screws.
 (4 qty.) 3/16"-18 x 5" Hex Head Cap Screws.
 (4 qty.) 3/16" x 1 1/2" Fender Washers.
 (4 qty.) 1/4" x 20 x 2" Flat Head Self Tapping Screws.

12" Balustrade System Baluster Bottom Rail Radius

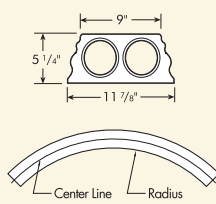

Part Number	Radius	Center Line Length	Baluster Rail Installation Kit* (See Installation Guide Page 38)	Rail Support Block (Page 32 BL)
BBRR12X48	48"	75" (1/4 Circle)	BRK12	RSB4X4X6
BBRR12X60	60"	94" (1/4 Circle)	BRK12	RSB4X4X6
BBRR12X77	76 1/2"	122" (1/4 Circle)	BRK12	RSB4X4X6
BBRR12X96	96"	120" (1/5 Circle)	BRK12	RSB4X4X6
BBRR12X110	110"	78" (1/8 Circle)	BRK12	RSB4X4X6
BBRR12X126	126"	102" (1/8 Circle)	BRK12	RSB4X4X6
NEW BBRR12X192	192 1/2"	100" (1/12 Circle)	BRK12	RSB4X4X6
BBRR12X247	246 15/16"	98" (1/16 Circle)	BRK12	RSB4X4X6

*Includes hardware to mount top and bottom rail to a baluster:
 (4 qty.) Bear Claw Brackets.
 (4 qty.) 3/16"-18 Clip Nuts.
 (16 qty.) #12 x 3/4" Pan Head Screws.
 (4 qty.) 3/16"-18 x 5" Hex Head Cap Screws.
 (4 qty.) 3/16" x 1 1/2" Fender Washers.
 (4 qty.) 1/4" x 20 x 2" Flat Head Self Tapping Screws.

12" Balustrade System Newel Post

Three piece Post reinforced, height trimable.

UNATTACHED ACCESSORIES

Newel Post Installation Kit*
(See Installation Guide Page 38)

Moulding - Miter and cut for Newel post accent.
(See Mouldings Section/Catalog Pages 26 ML-27 ML)

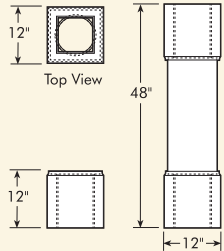

Part Number
NP12X48

NPK12

MLD601, MLD602, MLD610, MLD611

*Includes hardware to secure one NP12X48:
(2 qty.) 3/8" - 16 Hex Nuts.
(2 qty.) 3/8" - Lock Washers.
(2 qty.) 3/8" - USS Flat Washers.
(2 qty.) Corner Brackets.
(2 qty.) 3/8" - 16 x 39" Threaded Rods.
(8 qty.) #10 x 3/8" Flat Head Self Tapping Screws.
(1 qty.) Steel Base Plate.

12" Balustrade System Newel Post Accessories

Part Number

Coordinating Newel Post Accessories

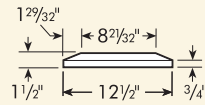

PST13X13F
Post Top - Flat

B10X13

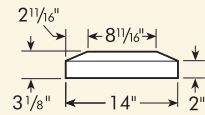

PST14X14F
Post Top - Flat

B10X13

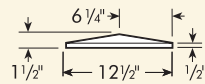

PST13X13P
Post Top - Peaked

—

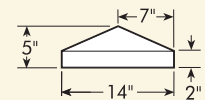

PST14X14P
Post Top - Peaked

—

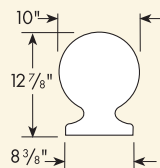

B10X13
Ball

PST13X13F
PST14X14F